

PLAN VIEW

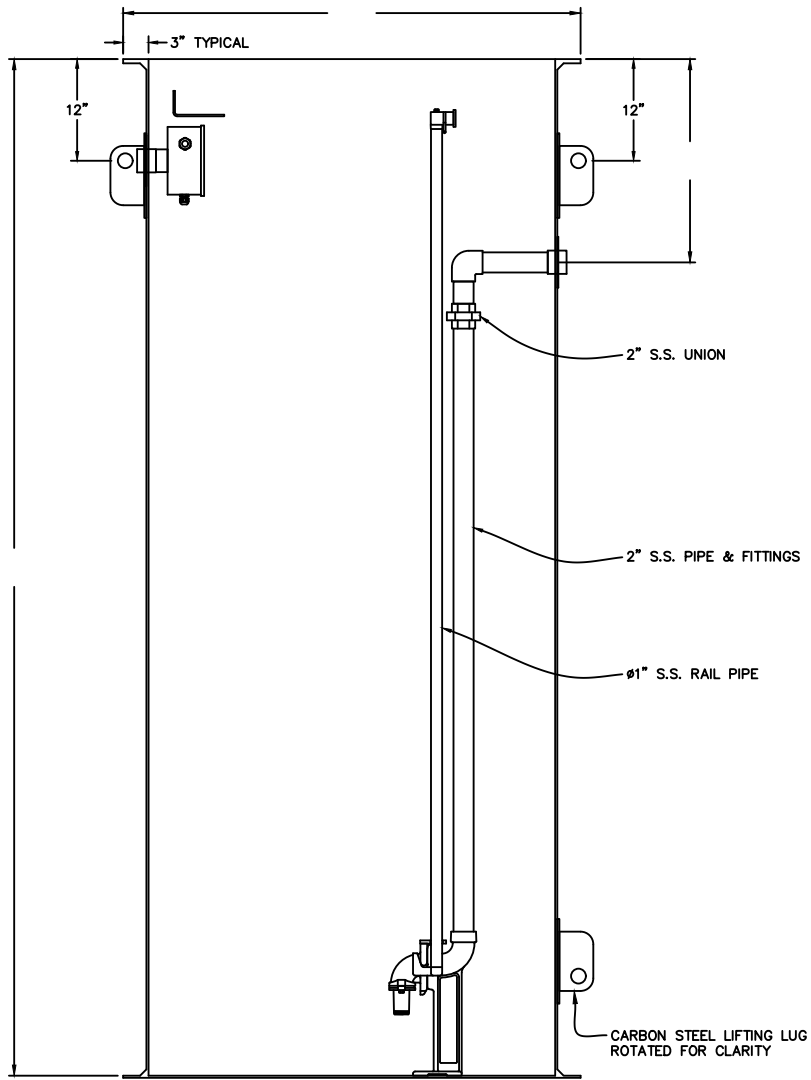

SECTIONAL ELEVATION VIEW



STEELE PLASTICS, INC.
 1280 Sturgis Rd.
 Conway, AR 72034
 (501) 327-5122 Fax (501) 327-0807

| | |
|---|-------------------------|
| TITLE PACKAGE SIMPLEX 2" NO VALVES – S.S. 10' | |
| PROJECT | JOB NO. |
| CUSTOMER | P.O. NO. |
| | DWG. NO. PFS200-NV-SS10 |