

PLAN VIEW

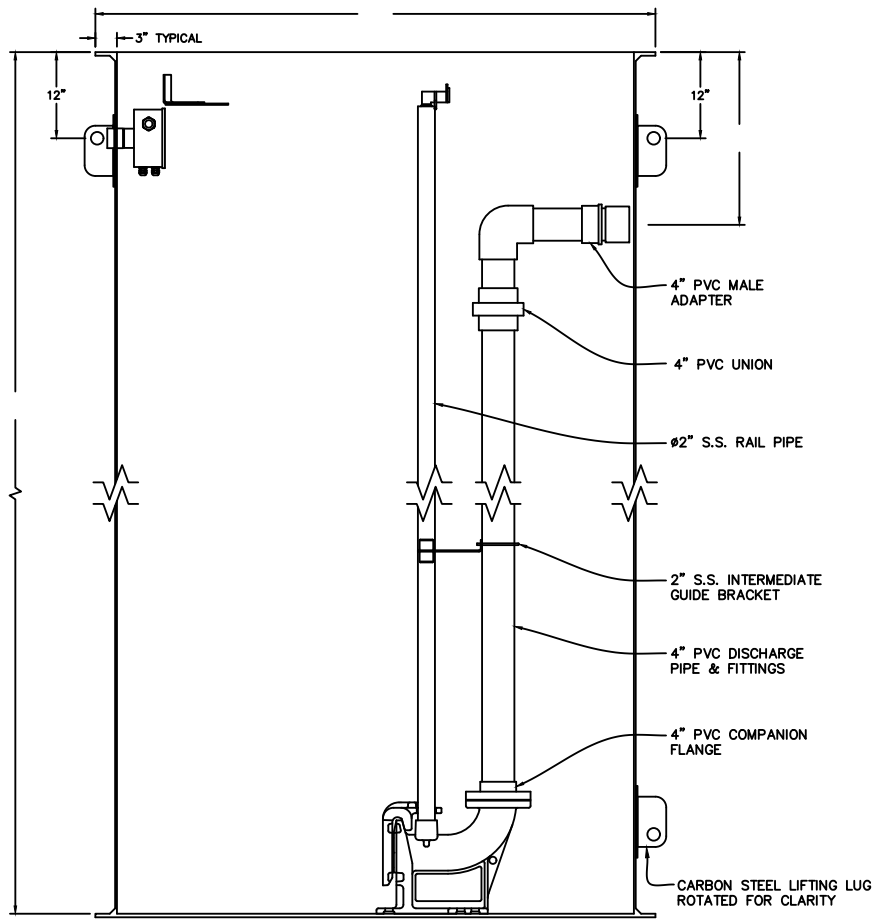

SECTIONAL ELEVATION VIEW



STEELE PLASTICS, INC.
 1280 Sturgis Rd.
 Conway, AR 72034
 (501) 327-5122 Fax (501) 327-0807

TITLE PACKAGE DUPLEX 4" NO VALVES - PVC 20'	
PROJECT	JOB NO.
CUSTOMER	P.O. NO.
	DWG. NO. PFD400-NV-PVC20