

PLAN VIEW

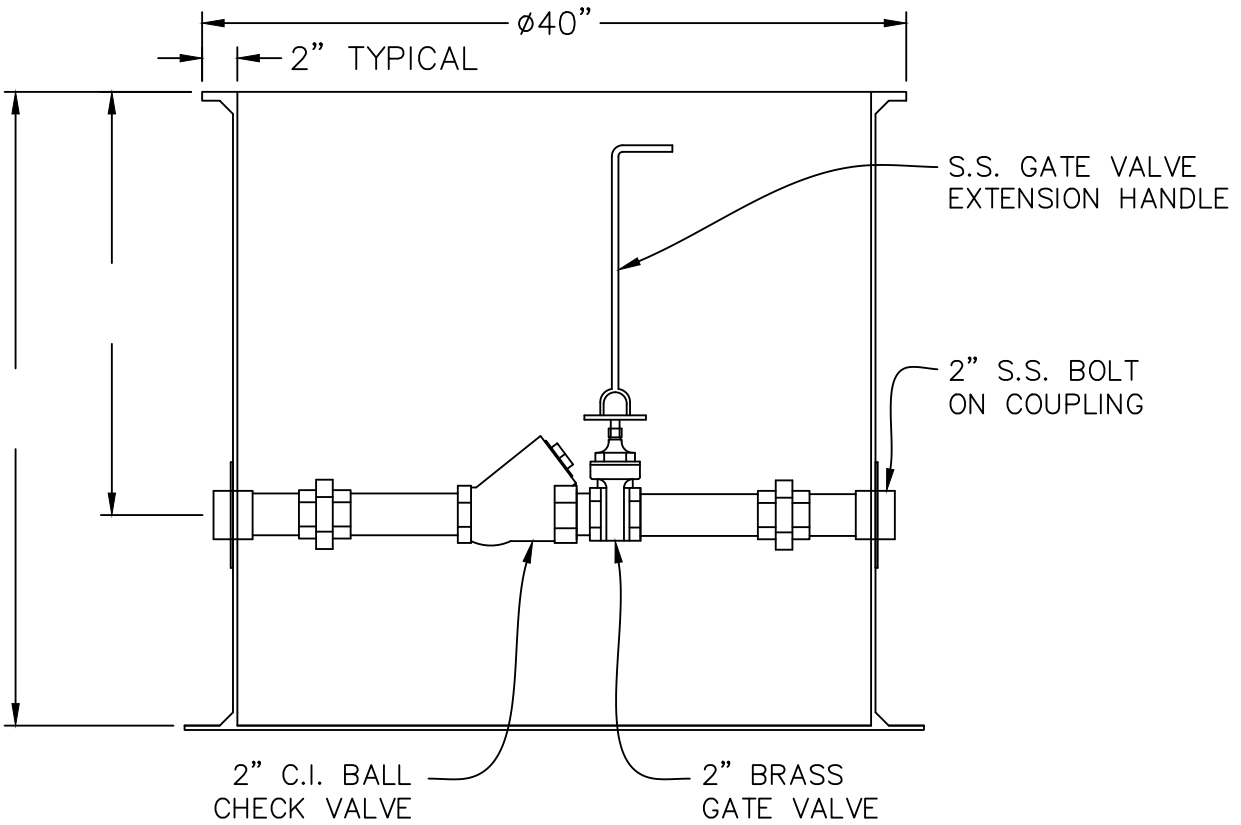

SECTIONAL ELEVATION VIEW



STEELE PLASTICS, INC.
 1280 Sturgis Rd.
 Conway, AR 72034
 (501) 327-5122 Fax (501) 327-0807

TITLE VALVE BOX PACKAGE SIMPLEX - 2" S.S. PIPE

PROJECT

JOB NO.

P.O. NO.

CUSTOMER

DWG. NO. PVBS200-SS